

Stonedilgroup[®]
srl



www.stonedilgroup.com



Experience and realization of fountains, barbecues and other outdoor decors in different sizes and shapes made locally solely from stone, make our company a landmark for all who wish to beautify and furnish their villa or garden with real life works of art.



Esperienza nella lavorazione e realizzazione di fontane, barbecue ed arredo giardino di varie forme e dimensioni, ricavate dal frutto di mani esperte e l'utilizzo della sola pietra di origini prettamente locale fanno della nostra azienda un punto di riferimento per tutti coloro che intendono abbellire e/o arredare la propria villa o il proprio giardino, con queste vere e proprie opere d'arte.



Legend
Legenda (cm)

A	115,00
B	85,00
h	130,00

NAME	MODEL	TYPE	ID NUMBER	WEIGHT	PROD. YEAR	PROG. SERIES	SIZE
KAUSI - A	LUXURY	FOUNTAIN	#1	10 QL	2011	1-1	1,00X1,00
NOME	MODELLO	TIPO	NUMERO	PESO	ANNO DI PROD.	NUMERO Progr.	DM
KAUSI - A	LUSSO	FONTANA	#1	10 QL	2011	1-1	1,00X1,00



Legend
Legenda (cm)

A	115,00
B	85,00
h	130,00

NAME	MODEL	TYPE	ID NUMBER	WEIGHT	PROD. YEAR	PROG. SERIES	SIZE
KAUSI - B	LUXURY	FOUNTAIN	#1	10 QL	2011	1-1	1,00X1,00
NOME	MODELLO	TIPO	NUMERO	PESO	ANNO DI PROD.	NUMERO Progr.	DM
KAUSI - B	LUSSO	FONTANA	#1	10 QL	2011	1-1	1,00X1,00



Legend
Legenda (cm)

A	115,00
B	85,00
h	130,00



NAME	MODEL	TYPE	ID NUMBER	WEIGHT	PROD. YEAR	PROG. SERIES	SIZE
KAUSI - C	LUXURY	FOUNTAIN	#1	10 QL	2011	1-1	1,00X1,00
NOME	MODELLO	TIPO	NUMERO	PESO	ANNO DI PROD.	NUMERO Progr.	DM
KAUSI - C	LUSSO	FONTANA	#1	10 QL	2011	1-1	1,00X1,00



Legend
Legenda (cm)

A	115,00
B	85,00
h	130,00



NAME	MODEL	TYPE	ID NUMBER	WEIGHT	PROD. YEAR	PROG. SERIES	SIZE
KAUSI - D/L	MIAMI	FOUNTAIN	#1	10 QL	2011	1-7	1,00X1,00
NOME	MODELLO	TIPO	NUMERO	PESO	ANNO DI PROD.	NUMERO Progr.	DM
KAUSI - D/L	MIAMI	FONTANA	#1	10 QL	2011	1-7	1,00X1,00



Legend
Legenda (cm)

A	100,00
B	100,00
h	130,00



NAME	MODEL	TYPE	ID NUMBER	WEIGHT	PROD. YEAR	PROG. SERIES	SIZE
KAUSI - M	LUXURY	FOUNTAIN	#1	15 QL	2011	1-1	1,00X1,00
NOME	MODELLO	TIPO	NUMERO	PESO	ANNO DI PROD.	NUMERO PROGR.	DM
KAUSI - M	LUSSO	FONTANA	#1	15 QL	2011	1-1	1,00X1,00



Legend
Legenda (cm)

A	115,00
B	85,00
h	130,00

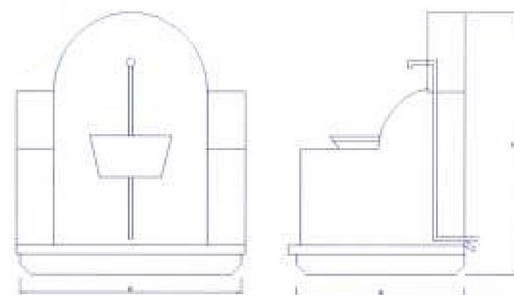

NAME	MODEL	TYPE	ID NUMBER	WEIGHT	PROD. YEAR	PROG. SERIES	SIZE
KAUSI - N	COMMERCIAL	FOUNTAIN	#1	10 QL	2011	1-1	1,00X1,00
NOME	MODELLO	TIPO	NUMERO	PESO	ANNO DI PROD.	NUMERO PROGR.	DM
KAUSI - N	COMMERCIALE	FONTANA	#1	10 QL	2011	1-1	1,00X1,00



Legend
Legenda (cm)

A	115,00
B	85,00
h	130,00

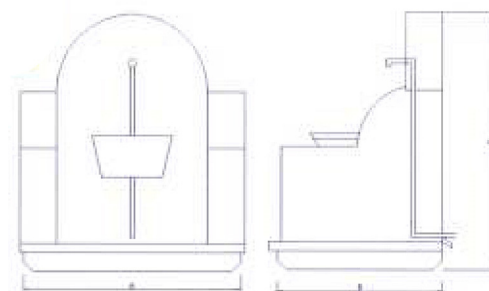

NAME	MODEL	TYPE	ID NUMBER	WEIGHT	PROD. YEAR	PROG. SERIES	SIZE
KAUSI - O	COMMERCIAL	FOUNTAIN	#1	10 QL	2011	1-1	1,00X1,00
NOME	MODELLO	TIPO	NUMERO	PESO	ANNO DI PROD.	NUMERO PROGR.	DM
KAUSI - O	COMMERCIALE	FONTANA	#1	10 QL	2011	1-1	1,00X1,00



Legend
Legenda (cm)

A	115,00
B	85,00
h	130,00

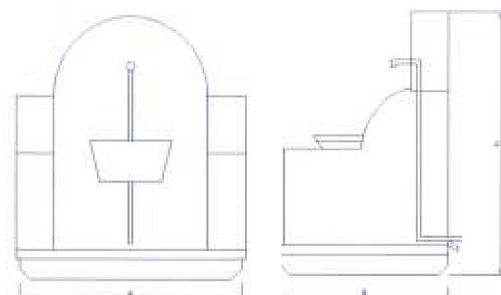

NAME	MODEL	TYPE	ID NUMBER	WEIGHT	PROD. YEAR	PROG. SERIES	SIZE
KAUSI - P	COMMERCIAL	FOUNTAIN	#1	10 QL	2011	1-1	1,00X1,00
NOME	MODELLO	TIPO	NUMERO	PESO	ANNO DI PROD.	NUMERO PROGR.	DM
KAUSI - P	COMMERCIALE	FONTANA	#1	10 QL	2011	1-1	1,00X1,00



Legend
Legenda (cm)

A	200,00
B	95,00
h	130,00



NAME	MODEL	TYPE	ID NUMBER	WEIGHT	PROD. YEAR	PROG. SERIES	SIZE
GENERAL	EXTRA	FOUNTAIN	#17	25 QL	2011	1-1	2,00X1,00
NOME	MODELLO	TIPO	NUMERO	PESO	ANNO DI PROD.	NUMERO PROGR.	DM
GENERAL	EXTRA	FONTANA	#17	25 QL	2011	1-1	2,00X1,00



Legend
Legenda (cm)

A	200,00
B	95,00
h	130,00



NAME	MODEL	TYPE	ID NUMBER	WEIGHT	PROD. YEAR	PROG. SERIES	SIZE
PERSEFONE	LUXURY	FOUNTAIN	#20	25 QL	2012	1-1	2,00X1,00
NOME	MODELLO	TIPO	NUMERO	PESO	ANNO DI PROD.	NUMERO PROGR.	DM
PERSEFONE	LUSSO	FONTANA	#20	25 QL	2012	1-1	2,00X1,00



Legend
Legenda (cm)

A	200,00
B	95,00
h	130,00



NAME	MODEL	TYPE	ID NUMBER	WEIGHT	PROD. YEAR	PROG. SERIES	SIZE
DAFNE	LUXURY	FOUNTAIN	#21	25 QL	2012	1-1	2,00X1,00
NOME	MODELLO	TIPO	NUMERO	PESO	ANNO DI PROD.	NUMERO PROGR.	DM
DAFNE	LUSSO	FONTANA	#21	25 QL	2012	1-1	2,00X1,00



Legend
Legenda (cm)

A	200,00
B	95,00
h	130,00



NAME	MODEL	TYPE	ID NUMBER	WEIGHT	PROD. YEAR	PROG. SERIES	SIZE
NINFA	COMMERCIAL	FOUNTAIN	#22	25 QL	2011	1-1	2,00X1,00
NOME	MODELLO	TIPO	NUMERO	PESO	ANNO DI PROD.	NUMERO PROGR.	DM
NINFA	COMMERCIALE	FONTANA	#22	25 QL	2011	1-1	2,00X1,00



Legend
Legenda (cm)

A	200,00
B	100,00
h	130,00



NAME	MODEL	TYPE	ID NUMBER	WEIGHT	PROD. YEAR	PROG. SERIES	SIZE
VICTORIA	EXCLUSIVE	FOUNTAIN	#25	25 QL	2013	1-1	2,00X1,00
NOME	MODELLO	TIPO	NUMERO	PESO	ANNO DI PROD.	NUMERO PROGR.	DM
VICTORIA	EXCLUSIVO	FONTANA	#25	25 QL	2013	1-1	2,00X1,00



Legend
Legenda (cm)

A	200,00
B	95,00
h	130,00



NAME	MODEL	TYPE	ID NUMBER	WEIGHT	PROD. YEAR	PROG. SERIES	SIZE
FEBO	EXTRA	FOUNTAIN	#24	25 QL	2012	1-1	2,00X1,00
NOME	MODELLO	TIPO	NUMERO	PESO	ANNO DI PROD.	NUMERO PROGR.	DM
FEBO	EXTRA	FONTANA	#24	25 QL	2012	1-1	2,00X1,00



Legend
Legenda (cm)

A	200,00
B	95,00
h	130,00

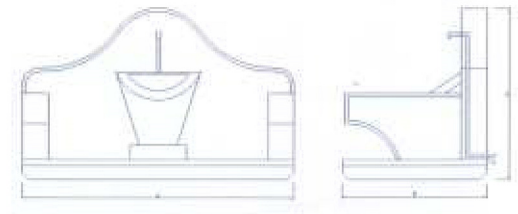

NAME	MODEL	TYPE	ID NUMBER	WEIGHT	PROD. YEAR	PROG. SERIES	SIZE
ANDROMEDA	COMMERCIAL	FOUNTAIN	#8	25 QL	2011	1-1	2,00X1,00
NOME	MODELLO	TIPO	NUMERO	PESO	ANNO DI PROD.	NUMERO Progr.	DM
ANDROMEDA	COMMERCIALE	FONTANA	#8	25 QL	2011	1-1	2,00X1,00



Legend
Legenda (cm)

A	200,00
B	95,00
h	130,00

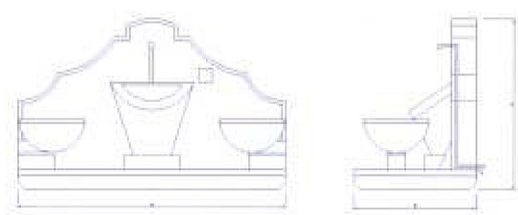

NAME	MODEL	TYPE	ID NUMBER	WEIGHT	PROD. YEAR	PROG. SERIES	SIZE
BRISEIDE	LUXURY	FOUNTAIN	#2	25 QL	2011	1-1	2,00X1,00
NOME	MODELLO	TIPO	NUMERO	PESO	ANNO DI PROD.	NUMERO Progr.	DM
BRISEIDE	LUSSO	FONTANA	#2	25 QL	2011	1-1	2,00X1,00



Legend
Legenda (cm)

A	200,00
B	95,00
h	130,00

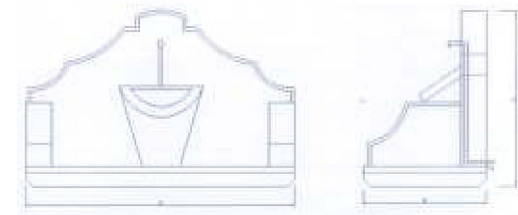

NAME	MODEL	TYPE	ID NUMBER	WEIGHT	PROD. YEAR	PROG. SERIES	SIZE
HEKATE	COMMERCIAL	FOUNTAIN	#15	25 QL	2010	1-1	2,00X1,00
NOME	MODELLO	TIPO	NUMERO	PESO	ANNO DI PROD.	NUMERO Progr.	DM
HEKATE	COMMERCIALE	FONTANA	#15	25 QL	2010	1-1	2,00X1,00



Legend
Legenda (cm)

A	115,00
B	95,00
h	130,00

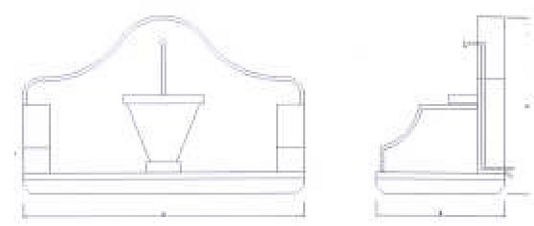

NAME	MODEL	TYPE	ID NUMBER	WEIGHT	PROD. YEAR	PROG. SERIES	SIZE
NAUSICAA	COMMERCIAL	FOUNTAIN	#4	25 QL	2011	1-1	2,00X1,00
NOME	MODELLO	TIPO	NUMERO	PESO	ANNO DI PROD.	NUMERO PROGR.	DM
NAUSICAA	COMMERCIALE	FONTANA	#4	25 QL	2011	1-1	2,00X1,00



Legend
Legenda (cm)

A	200,00
B	95,00
h	130,00

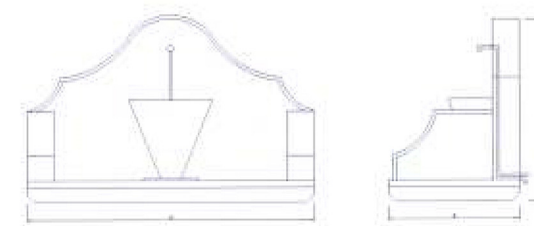

NAME	MODEL	TYPE	ID NUMBER	WEIGHT	PROD. YEAR	PROG. SERIES	SIZE
ISIDE	COMMERCIAL	FOUNTAIN	#5	25 QL	2011	1-1	2,00X1,00
NOME	MODELLO	TIPO	NUMERO	PESO	ANNO DI PROD.	NUMERO PROGR.	DM
ISIDE	COMMERCIALE	FONTANA	#5	25 QL	2011	1-1	2,00X1,00



Legend
Legenda (cm)

A	200,00
B	95,00
h	130,00

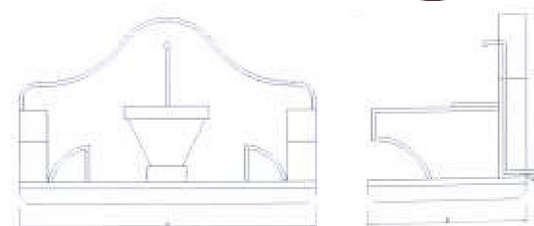

NAME	MODEL	TYPE	ID NUMBER	WEIGHT	PROD. YEAR	PROG. SERIES	SIZE
MEDEA	EXTRA	FOUNTAIN	#6	25 QL	2011	1-1	2,00X1,00
NOME	MODELLO	TIPO	NUMERO	PESO	ANNO DI PROD.	NUMERO PROGR.	DM
MEDEA	EXTRA	FONTANA	#6	25 QL	2011	1-1	2,00X1,00



Legend
Legenda (cm)

A	115,00
B	95,00
h	130,00

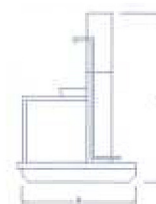
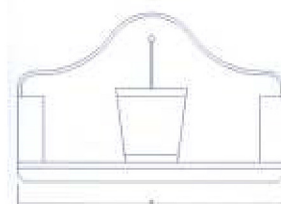

NAME	MODEL	TYPE	ID NUMBER	WEIGHT	PROD. YEAR	PROG. SERIES	SIZE
AFRODITE	COMMERCIAL	FOUNTAIN	#7	25 QL	2011	1-1	2,00X1,00
NOME	MODELLO	TIPO	NUMERO	PESO	ANNO DI PROD.	NUMERO Progr.	DM
AFRODITE	COMMERCIALE	FONTANA	#7	25 QL	2011	1-1	2,00X1,00



Legend
Legenda (cm)

A	200,00
B	95,00
h	130,00

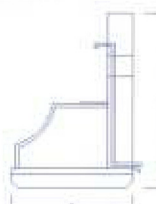
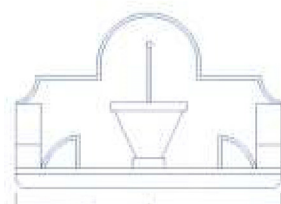

NAME	MODEL	TYPE	ID NUMBER	WEIGHT	PROD. YEAR	PROG. SERIES	SIZE
DESIDERIA	EXTRA	FOUNTAIN	#8	25 QL	2011	1-1	2,00X1,00
NOME	MODELLO	TIPO	NUMERO	PESO	ANNO DI PROD.	NUMERO Progr.	DM
DESIDERIA	EXTRA	FONTANA	#8	25 QL	2011	1-1	2,00X1,00



Legend
Legenda (cm)

A	200,00
B	95,00
h	130,00

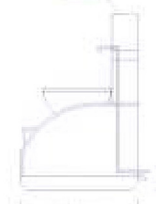
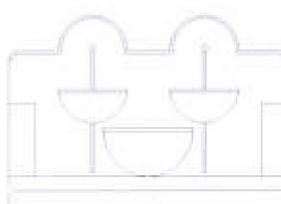

NAME	MODEL	TYPE	ID NUMBER	WEIGHT	PROD. YEAR	PROG. SERIES	SIZE
ARACNE	EXTRA	FOUNTAIN	#23	25 QL	2011	1-1	2,00X1,00
NOME	MODELLO	TIPO	NUMERO	PESO	ANNO DI PROD.	NUMERO Progr.	DM
ARACNE	EXTRA	FONTANA	#23	25 QL	2011	1-1	2,00X1,00



Legend
Legenda (cm)

A	200,00
B	95,00
h	130,00

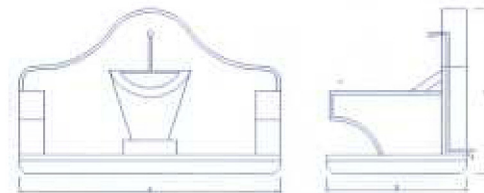

NAME	MODEL	TYPE	ID NUMBER	WEIGHT	PROD. YEAR	PROG. SERIES	SIZE
SELENE	COMMERCIAL	FOUNTAIN	#8	25 QL	2011	1-1	2,00X1,00
NOME	MODELLO	TIPO	NUMERO	PESO	ANNO DI PROD.	NUMERO PROGR.	DM
SELENE	COMMERCIALE	FONTANA	#8	25 QL	2011	1-1	2,00X1,00



Legend
Legenda (cm)

A	200,00
B	95,00
h	130,00

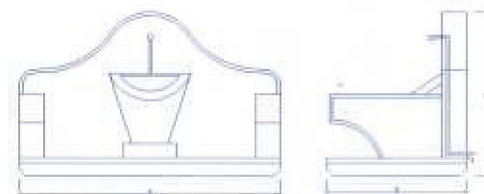

NAME	MODEL	TYPE	ID NUMBER	WEIGHT	PROD. YEAR	PROG. SERIES	SIZE
SELENE	COMMERCIAL	FOUNTAIN	#8	25 QL	2011	1-1	2,00X1,00
NOME	MODELLO	TIPO	NUMERO	PESO	ANNO DI PROD.	NUMERO PROGR.	DM
SELENE	COMMERCIALE	FONTANA	#8	25 QL	2011	1-1	2,00X1,00



Legend
Legenda (cm)

A	200,00
B	95,00
h	130,00

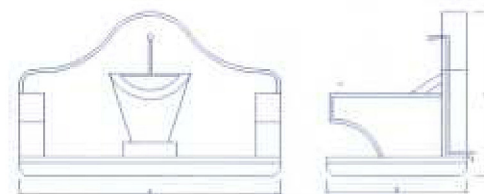

NAME	MODEL	TYPE	ID NUMBER	WEIGHT	PROD. YEAR	PROG. SERIES	SIZE
SELENE	COMMERCIAL	FOUNTAIN	#8	25 QL	2011	1-1	2,00X1,00
NOME	MODELLO	TIPO	NUMERO	PESO	ANNO DI PROD.	NUMERO PROGR.	DM
SELENE	COMMERCIALE	FONTANA	#8	25 QL	2011	1-1	2,00X1,00



Legend
Legenda (cm)

A	200,00
B	95,00
h	130,00

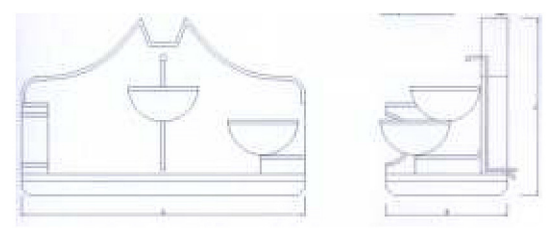

NAME	MODEL	TYPE	ID NUMBER	WEIGHT	PROD. YEAR	PROG. SERIES	SIZE
LUCREZIA	EXTRA	FOUNTAIN	#13	25 QL	2011	1-1	2,00X1,00
NOME	MODELLO	TIPO	NUMERO	PESO	ANNO DI PROD.	NUMERO Progr.	DM
LUCREZIA	EXTRA	FONTANA	#13	25 QL	2011	1-1	2,00X1,00



Legend
Legenda (cm)

A	200,00
B	95,00
h	130,00

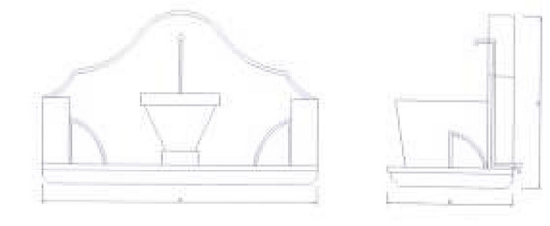

NAME	MODEL	TYPE	ID NUMBER	WEIGHT	PROD. YEAR	PROG. SERIES	SIZE
DEMETRA	EXTRA	FOUNTAIN	#16	25 QL	2011	1-1	2,00X1,00
NOME	MODELLO	TIPO	NUMERO	PESO	ANNO DI PROD.	NUMERO Progr.	DM
DEMETRA	EXTRA	FONTANA	#16	25 QL	2011	1-1	2,00X1,00



Legend
Legenda (cm)

A	200,00
B	95,00
h	130,00

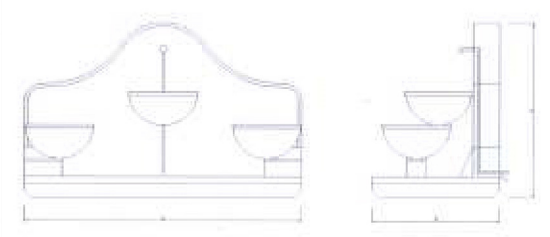

NAME	MODEL	TYPE	ID NUMBER	WEIGHT	PROD. YEAR	PROG. SERIES	SIZE
SAFFO	LUXURY	FOUNTAIN	#3	25 QL	2011	1-1	2,00X1,00
NOME	MODELLO	TIPO	NUMERO	PESO	ANNO DI PROD.	NUMERO Progr.	DM
SAFFO	LUSSO	FONTANA	#3	25 QL	2011	1-1	2,00X1,00



Legend
Legenda (cm)

h1	215,00
h2	250,00

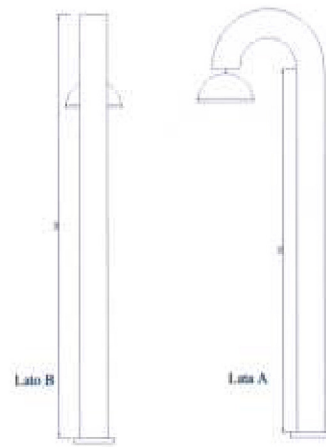

NAME	MODEL	TYPE	ID NUMBER	WEIGHT	PROD. YEAR	PROG. SERIES	SIZE			
LUNA	LUXURY	STREET LAMP	#4	5 QL	2011	1-1	H 2,50			
NOME	MODELLO	TIPO	NUMERO	PESO	ANNO DI PROD.	NUMERO PROGR.	DM			
LUNA	LUSSO	LAMPIONE	#4	5 QL	2011	1-1	H 2,50			



Legend
Legenda (cm)

A	145,00
B	75,00
h	215,00

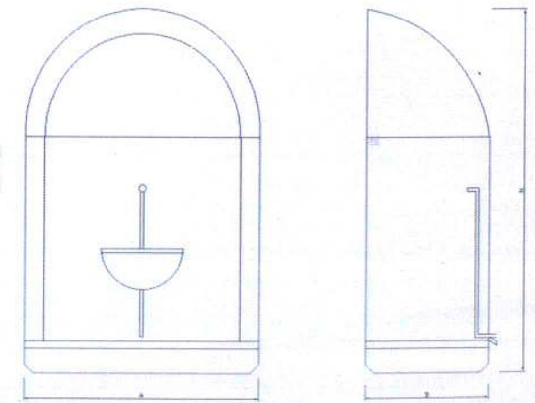

NAME	MODEL	TYPE	ID NUMBER	WEIGHT	PROD. YEAR	PROG. SERIES	SIZE			
ERACLE	EXTRA	FOUNTAIN	#12	30 QL	2011	1-1	1,50X0,80X2,00			
NOME	MODELLO	TIPO	NUMERO	PESO	ANNO DI PROD.	NUMERO PROGR.	DM			
ERACLE	EXTRA	FONTANA	#12	30 QL	2011	1-1	1,50X0,80X2,00			



Legend
Legenda (cm)

A	55,00
B	40,00
h	130,00

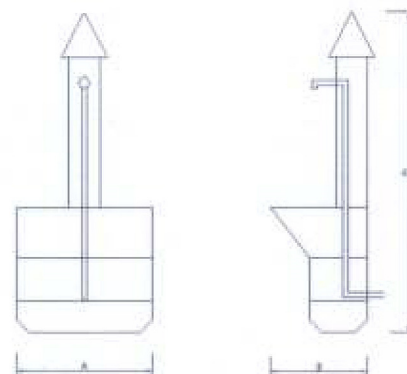

NAME	MODEL	TYPE	ID NUMBER	WEIGHT	PROD. YEAR	PROG. SERIES	SIZE			
CERERE	COMMERCIAL	FOUNTAIN	#19	5 QL	2011	1-1	0,25X0,60			
NOME	MODELLO	TIPO	NUMERO	PESO	ANNO DI PROD.	NUMERO PROGR.	DM			
CERERE	COMMERCIALE	FONTANA	#19	5 QL	2011	1-1	0,25X0,60			



Legend
Legenda (cm)

A	200,00
B	110,00
h	130,00

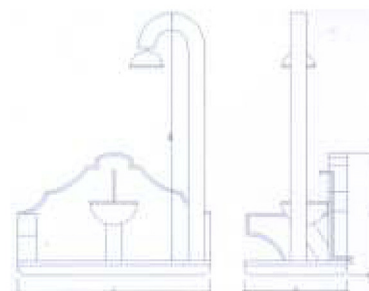

NAME	MODEL	TYPE	ID NUMBER	WEIGHT	PROD. YEAR	PROG. SERIES	SIZE
ATENA	LUXURY	FOUNTAIN	#14	25 QL+10 QL	2011	1-1	2,00X1,00X2,50
NOME	MODELLO	TIPO	NUMERO	PESO	ANNO DI PROD.	NUMERO PROGR.	DM
ATENA	LUSSO	FONTANA	#14	25 QL+10 QL	2011	1-1	2,00X1,00X2,50



Legend
Legenda (cm)

A	90,00
B	85,00
h	140,00

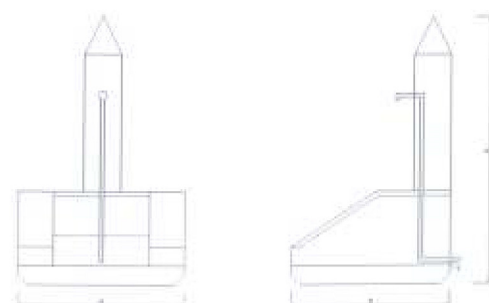

NAME	MODEL	TYPE	ID NUMBER	WEIGHT	PROD. YEAR	PROG. SERIES	SIZE
ERMES	COMMERCIAL	FOUNTAIN	#18	5 QL	2011	1-3	1,00X1,00
NOME	MODELLO	TIPO	NUMERO	PESO	ANNO DI PROD.	NUMERO PROGR.	DM
ERMES	COMMERCIALE	FONTANA	#18	5 QL	2011	1-3	1,00X1,00



Legend
Legenda (cm)

A	90,00
B	85,00
h	140,00

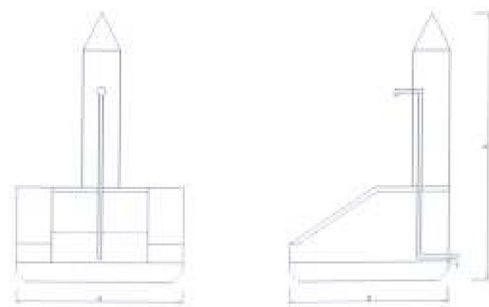

NAME	MODEL	TYPE	ID NUMBER	WEIGHT	PROD. YEAR	PROG. SERIES	SIZE
ERMES	COMMERCIAL	FOUNTAIN	#18	5 QL	2011	1-3	1,00X1,00
NOME	MODELLO	TIPO	NUMERO	PESO	ANNO DI PROD.	NUMERO PROGR.	DM
ERMES	COMMERCIALE	FONTANA	#18	5 QL	2011	1-3	1,00X1,00



Legend
Legenda (cm)

A	90,00
B	85,00
h	140,00

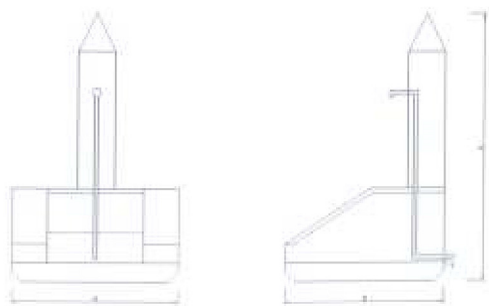

NAME	MODEL	TYPE	ID NUMBER	WEIGHT	PROD. YEAR	PROG. SERIES	SIZE
ERMES	COMMERCIAL	FOUNTAIN	#18	5 QL	2011	1-3	1,00X1,00
NOME	MODELLO	TIPO	NUMERO	PESO	ANNO DI PROD.	NUMERO PROGR.	DM
ERMES	COMMERCIALE	FONTANA	#18	5 QL	2011	1-3	1,00X1,00



Legend
Legenda (cm)

A	95,00
B	85,00
h	110,00

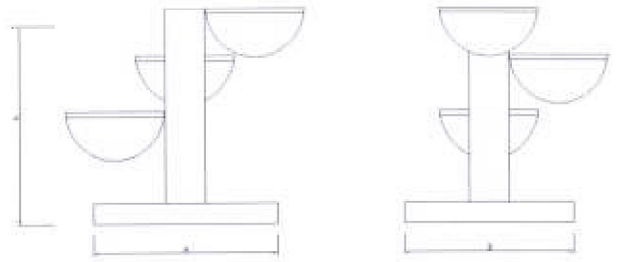

NAME	MODEL	TYPE	ID NUMBER	WEIGHT	PROD. YEAR	PROG. SERIES	SIZE
OLIMPO	LUXURY	FLOWERPOT	#1	5 QL	2010	1-1	0,90X0,80
NOME	MODELLO	TIPO	NUMERO	PESO	ANNO DI PROD.	NUMERO PROGR.	DM
OLIMPO	LUSSO	FIORIERA	#1	5 QL	2010	1-1	0,90X0,80



Legend
Legenda (cm)

A	80,00
B	80,00
h	100,00



NAME	MODEL	TYPE	ID NUMBER	WEIGHT	PROD. YEAR	PROG. SERIES	SIZE
GELO	EXTRA	FLOWERPOT	#6	5 QL	2013	1-1	0,80X0,80
NOME	MODELLO	TIPO	NUMERO	PESO	ANNO DI PROD.	NUMERO PROGR.	DM
GELO	EXTRA	FIORIERA	#6	5 QL	2013	1-1	0,80X0,80



Legend
Legenda (cm)

A	40,00
B	100,00
h	60,00

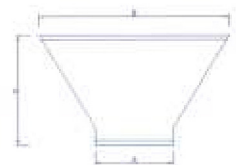

NAME	MODEL	TYPE	ID NUMBER	WEIGHT	PROD. YEAR	PROG. SERIES	SIZE
ULISSE	LUXURY	FLOWERPOT	#5	5 QL	2012	1-1	0,60X0,40
NOME	MODELLO	TIPO	NUMERO	PESO	ANNO DI PROD.	NUMERO PROGR.	DM
ULISSE	LUSSO	FIORIERA	#5	5 QL	2012	1-1	0,60X0,40

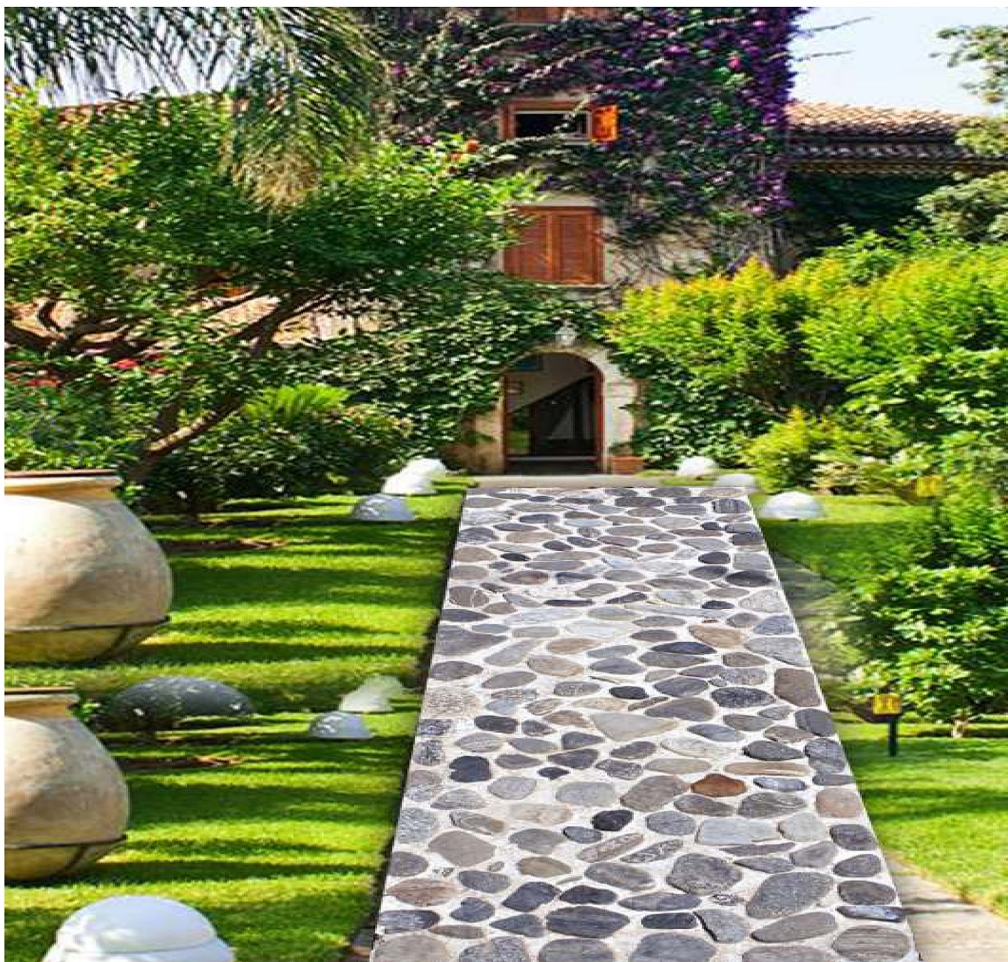

Legend
Legenda (cm)

A	195,00
B	50,00
h	9,00

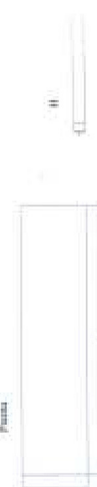

NAME TROIA	MODEL COMMERCIAL	TYPE ORNAMENT	ID NUMBER #3	QUANTITY 1 mq	PROD. YEAR 2010	PROG. SERIES 1-1	SIZE 2,00X1,00X0,10	
NOME TROIA	MODELLO COMMERCIALE	TIPO ORNAMENTO	NUMERO #3	QUANTITA' 1 mq	ANNO DI PROD. 2010	NUMERO Progr. 1-1	DM 2,00X1,00X0,10	



Legend
Legenda (cm)

A	80,00
B	90,00
h	130,00



NAME CALIPTUS	MODEL LUXURY	TYPE FLOWERPOT	ID NUMBER #2	WEIGHT 5 QL	PROD. YEAR 2012	PROG. SERIES 1-1	SIZE 0,80X0,80	
NOME CALIPTUS	MODELLO LUSSO	TIPO FIORIERA	NUMERO #2	PESO 5 QL	ANNO DI PROD. 2012	NUMERO Progr. 1-1	DM 0,80X0,80	



Legend
Legenda (cm)

A	155,00
B	75,00
h	90,00



BARBECUE

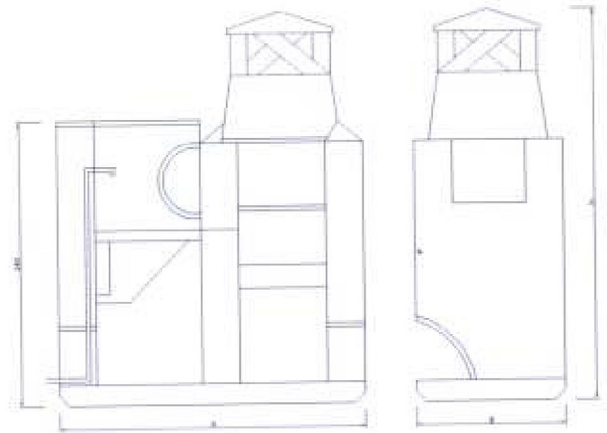

NAME	MODEL	TYPE	ID NUMBER	WEIGHT	PROD. YEAR	PROG. SERIES	SIZE
LUCINA	EXTRA	BARBECUE	#1	25 QL	2010	1-1	1,60X0,80
NOME	MODELLO	TIPO	NUMERO	PESO	ANNO DI PROD.	NUMERO PROGR.	DM
LUCINA	EXTRA	BARBECUE	#1	25 QL	2010	1-1	1,60X0,80



Legend
Legenda (cm)

A	155,00
B	75,00
h	190,00

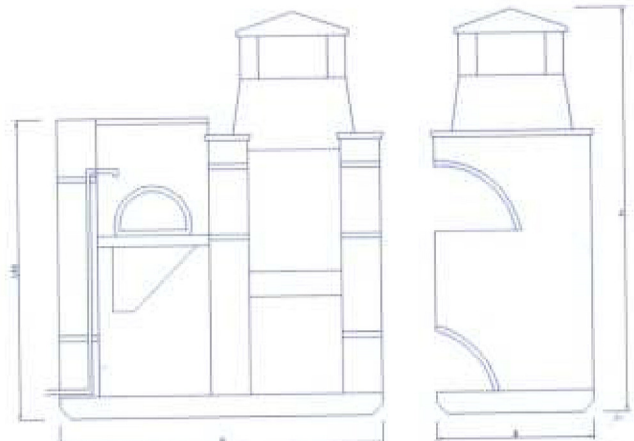

NAME	MODEL	TYPE	ID NUMBER	WEIGHT	PROD. YEAR	PROG. SERIES	SIZE
REGINA	LUXURY	BARBECUE	#2	25 QL	2012	1-1	1,60X0,80
NOME	MODELLO	TIPO	NUMERO	PESO	ANNO DI PROD.	NUMERO PROGR.	DM
REGINA	LUSSO	BARBECUE	#2	25 QL	2012	1-1	1,60X0,80



Legend
Legenda (cm)

A	100,00
B	85,00
h	210,00

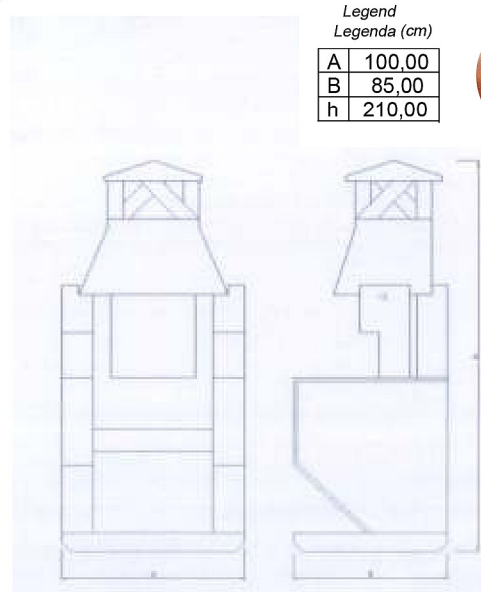

NAME	MODEL	TYPE	ID NUMBER	WEIGHT	PROD. YEAR	PROG. SERIES	SIZE
CUPIDO	EXTRA	BARBECUE	#6	25 QL	2012	1-1	1,00X0,80
NOME	MODELLO	TIPO	NUMERO	PESO	ANNO DI PROD.	NUMERO PROGR.	DM
CUPIDO	EXTRA	BARBECUE	#6	25 QL	2012	1-1	1,00X0,80



Legend
Legenda (cm)

A	155,00
B	75,00
h	210,00



BARBECUE

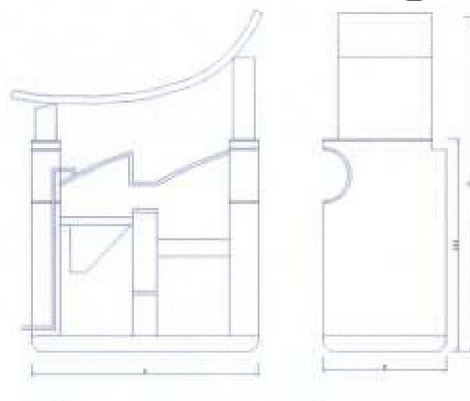

NAME	MODEL	TYPE	ID NUMBER	WEIGHT	PROD. YEAR	PROG. SERIES	SIZE
GAIA	EXTRA	BARBECUE	#4	25 QL	2011	1-1	1,50X0,80
NOME	MODELLO	TIPO	NUMERO	PESO	ANNO DI PROD.	NUMERO PROGR.	DM
GAIA	EXTRA	BARBECUE	#4	25 QL	2011	1-1	1,50X0,80



Legend
Legenda (cm)

A	160,00
B	85,00
h	190,00

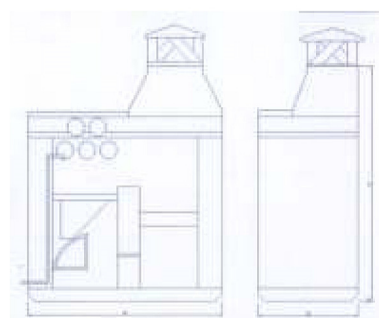

NAME	MODEL	TYPE	ID NUMBER	WEIGHT	PROD. YEAR	PROG. SERIES	SIZE
GIOVE	COMMERCIAL	BARBECUE	#5	25 QL	2010	1-1	1,60X0,80
NOME	MODELLO	TIPO	NUMERO	PESO	ANNO DI PROD.	NUMERO PROGR.	DM
GIOVE	COMMERCIALE	BARBECUE	#5	25 QL	2010	1-1	1,60X0,80



Legend
Legenda (cm)

A	155,00
B	75,00
h	160,00

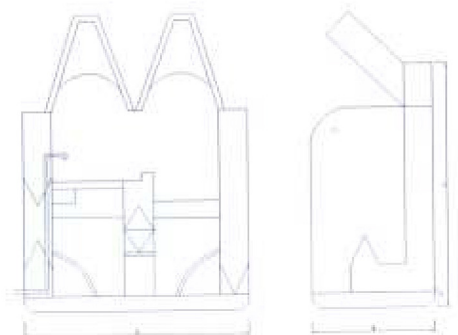

NAME	MODEL	TYPE	ID NUMBER	WEIGHT	PROD. YEAR	PROG. SERIES	SIZE
MINERVA	EXTRA	BARBECUE	#3	25 QL	2012	1-1	1,50X0,80
NOME	MODELLO	TIPO	NUMERO	PESO	ANNO DI PROD.	NUMERO PROGR.	DM
MINERVA	EXTRA	BARBECUE	#3	25 QL	2012	1-1	1,50X0,80



Legend

Legenda (cm)

A	100,00
B	85,00
h	210,00



BARBECUE

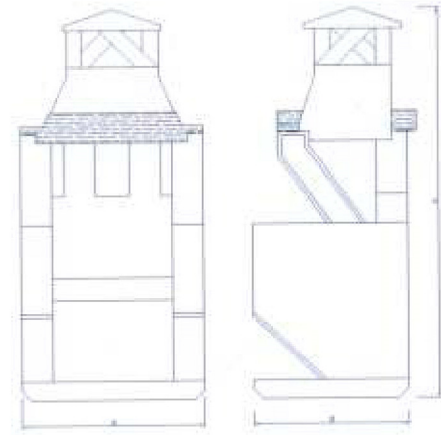

NAME	MODEL	TYPE	ID NUMBER	WEIGHT	PROD. YEAR	PROG. SERIES	SIZE
AURORA	EXTRA	BARBECUE	#7	25 QL	2010	1-1	1,00X0,80
NOME	MODELLO	TIPO	NUMERO	PESO	ANNO DI PROD.	NUMERO PROGR.	DM
AURORA	EXTRA	BARBECUE	#7	25 QL	2010	1-1	1,00X0,80



Legend

Legenda (cm)

A	100,00
B	85,00
h	210,00

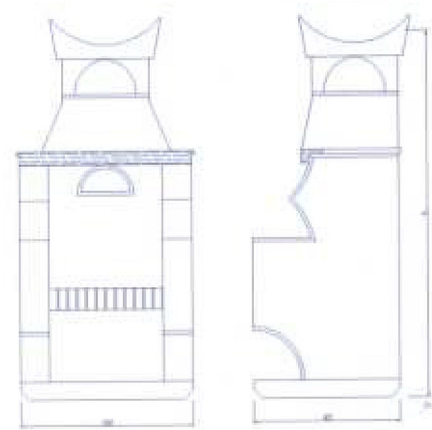

NAME	MODEL	TYPE	ID NUMBER	WEIGHT	PROD. YEAR	PROG. SERIES	SIZE
GIUNONE	LUXURY	BARBECUE	#8	25 QL	2012	1-1	1,00X0,80
NOME	MODELLO	TIPO	NUMERO	PESO	ANNO DI PROD.	NUMERO PROGR.	DM
GIUNONE	LUSSO	BARBECUE	#8	25 QL	2012	1-1	1,00X0,80



Legend

Legenda (cm)

A	100,00
B	85,00
h	210,00

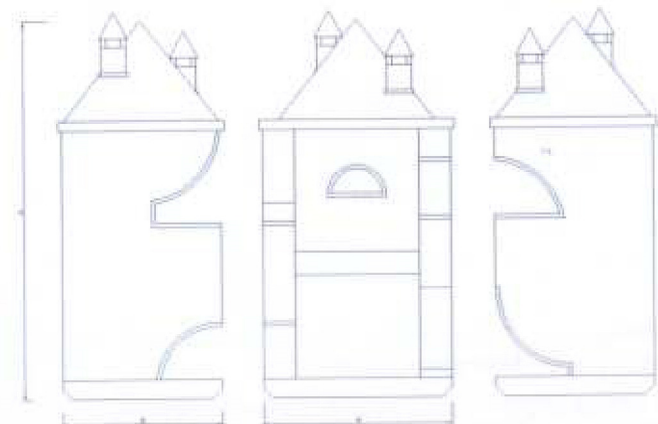

NAME	MODEL	TYPE	ID NUMBER	WEIGHT	PROD. YEAR	PROG. SERIES	SIZE
NETTUNO	EXTRA	BARBECUE	#9	25 QL	2011	1-1	1,00X0,80
NOME	MODELLO	TIPO	NUMERO	PESO	ANNO DI PROD.	NUMERO PROGR.	DM
NETTUNO	EXTRA	BARBECUE	#9	25 QL	2011	1-1	1,00X0,80



Legend
Legenda (cm)

A	100,00
B	100,00
h	210,00



NAME	MODEL	TYPE	ID NUMBER	WEIGHT	PROD. YEAR	PROG. SERIES	SIZE
CASE	LUXURY	BARBECUE	#15	15 QL	2013	1-1	1,00X1,00
NOME	MODELLO	TIPO	NUMERO	PESO	ANNO DI PROD.	NUMERO Progr.	DM
CASE	LUSSO	BARBECUE	#15	15 QL	2013	1-1	1,00X1,00



Legend
Legenda (cm)

A	100,00
B	100,00
h	210,00



NAME	MODEL	TYPE	ID NUMBER	WEIGHT	PROD. YEAR	PROG. SERIES	SIZE
OLIMPIA	LUXURY	BARBECUE	#11	15 QL	2012	1-1	1,00X1,00
NOME	MODELLO	TIPO	NUMERO	PESO	ANNO DI PROD.	NUMERO Progr.	DM
OLIMPIA	LUSSO	BARBECUE	#11	15 QL	2012	1-1	1,00X1,00



Legend
Legenda (cm)

A	100,00
B	100,00
h	210,00



NAME	MODEL	TYPE	ID NUMBER	WEIGHT	PROD. YEAR	PROG. SERIES	SIZE
ASIA	LUXURY	BARBECUE	#15	15 QL	2013	1-1	1,00 X 1,00
NOME	MODELLO	TIPO	NUMERO	PESO	ANNO DI PROD.	NUMERO PROGR.	DM
ASIA	LUSSURIA	BARBECUE	#15	15 QL	2013	1-1	1,00 X 1,00



Legend
Legenda (cm)

A	100,00
B	100,00
h	210,00



NAME	MODEL	TYPE	ID NUMBER	WEIGHT	PROD. YEAR	PROG. SERIES	SIZE
MARTE	LUXURY	BARBECUE	#11	15 QL	2012	1-1	1,00 X 1,00
NOME	MODELLO	TIPO	NUMERO	PESO	ANNO DI PROD.	NUMERO PROGR.	DM
MARTE	LUSSURIA	BARBECUE	#11	15 QL	2012	1-1	1,00 X 1,00



Legenda (cm)

A	100,00
B	100,00
h	210,00

BARBECUE

NAME	MODEL	TYPE	ID NUMBER	WEIGHT	PROD. YEAR	PROG. SERIES	SIZE
ORIENT	LUXURY	BARBECUE	#16	15 QL	2013	1-1	1,00X1,00
NOME	MODELLO	TIPO	NUMERO	PESO	ANNO DI PROD.	NUMERO Progr.	DM
ORIENT	LUSSO	BARBECUE	#16	15 QL	2013	1-1	1,00X1,00



Legend
Legenda (cm)

A	100,00
B	100,00
h	210,00



NAME	MODEL	TYPE	ID NUMBER	WEIGHT	PROD. YEAR	PROG. SERIES	SIZE
EUROPA	LUXURY	BARBECUE	#14	15 QL	2013	1-1	1,00X1,00
NOME	MODELLO	TIPO	NUMERO	PESO	ANNO DI PROD.	NUMERO Progr.	DM
EUROPA	LUSSO	BARBECUE	#14	15 QL	2013	1-1	1,00X1,00



Legend
Legenda (cm)

A	100,00
B	100,00
h	210,00



NAME	MODEL	TYPE	ID NUMBER	WEIGHT	PROD. YEAR	PROG. SERIES	SIZE
MAYA	LUXURY	BARBECUE	#13	15 QL	2012	1-1	1,00X1,00
NOME	MODELLO	TIPO	NUMERO	PESO	ANNO DI PROD.	NUMERO Progr.	DM
MAYA	LUSSO	BARBECUE	#13	15 QL	2012	1-1	1,00X1,00



Legend
Legenda (cm)

A	120,00
B	120,00
h	210,00



NAME	MODEL	TYPE	ID NUMBER	WEIGHT	PROD. YEAR	PROG. SERIES	SIZE
TURBO	LUXURY	BARBECUE	#10	15 QL	2012	1-1	1,20X1,20
NOME	MODELLO	TIPO	NUMERO	PESO	ANNO DI PROD.	NUMERO PROGR.	DM
TURBO	LUSSO	BARBECUE	#10	15 QL	2012	1-1	1,20X1,20



Legend
Legenda (cm)

A	200,00
B	120,00
h	210,00



NAME	MODEL	TYPE	ID NUMBER	WEIGHT	PROD. YEAR	PROG. SERIES	SIZE
MEXICOI	EXCLUSIVO	BARBECUE	#12	15 QL	2012	1-1	2,00X1,20
NOME	MODELLO	TIPO	NUMERO	PESO	ANNO DI PROD.	NUMERO PROGR.	DM
MEXICO	EXCLUSIVO	BARBECUE	#12	15 QL	2012	1-1	2,00X1,20



Legend
Legenda (cm)

A	200,00
B	120,00
h	100,00

NAME	MODEL	TYPE	ID NUMBER	WEIGHT	PROD. YEAR	PROG. SERIES	SIZE
VULCANO	EXCLUSIVE	OVEN	#1	20 QL	2013	1-1	2,00X1,20
NOME	MODELLO	TIPO	NUMERO	PESO	ANNO DI PROD.	NUMERO Progr.	DM
VULCANO	EXCLUSIVE	FORNO	#1	20 QL	2013	1-1	2,00X1,20



Legend
Legenda (cm)

A	200,00
B	120,00
h	100,00

NAME	MODEL	TYPE	ID NUMBER	WEIGHT	PROD. YEAR	PROG. SERIES	SIZE
DRINK	EXCLUSIVE	OVEN	#2	20 QL	2013	1-1	2,00X1,20
NOME	MODELLO	TIPO	NUMERO	PESO	ANNO DI PROD.	NUMERO Progr.	DM
DRINK	EXCLUSIVE	FORNO	#2	20 QL	2013	1-1	2,00X1,20



Legend
Legenda (cm)

A	200,00
B	120,00
h	100,00



NAME	MODEL	TYPE	ID NUMBER	WEIGHT	PROD. YEAR	PROG. SERIES	SIZE
CALLIOPE	EXCLUSIVE	OVEN	#3	20 QL	2013	1-1	2,00X1,20
NOME	MODELLO	TIPO	NUMERO	PESO	ANNO DI PROD.	NUMERO PROGR.	DM
CALLIOPE	EXCLUSIVE	FORNO	#3	20 QL	2013	1-1	2,00X1,20



Legend
Legenda (cm)

A	200,00
B	120,00
h	100,00



NAME	MODEL	TYPE	ID NUMBER	WEIGHT	PROD. YEAR	PROG. SERIES	SIZE
BOLLICINE	EXTREME	OVEN	#4	20 QL	2013	1-1	2,00X1,20
NOME	MODELLO	TIPO	NUMERO	PESO	ANNO DI PROD.	NUMERO PROGR.	DM
BOLLICINE	EXTREME	FORNO	#4	20 QL	2013	1-1	2,00X1,20



Stonedilgroup[®] srl

Stonedilgroup[®] srl

Via **E. Berlinguer**, 79 - 88025 **Maida** (Cz)

Tel. **339.7478448**

info@stonedilgroup.com

P.Iva 03236390799



WWW.STONEDILGROUP.COM



Stonedilgroup[®] srl

